

# GRETA MINI

IP65 IK07    $\frac{-0}{3 \times 2.5}$   

POLLARI | POLLARE | BOLLARD

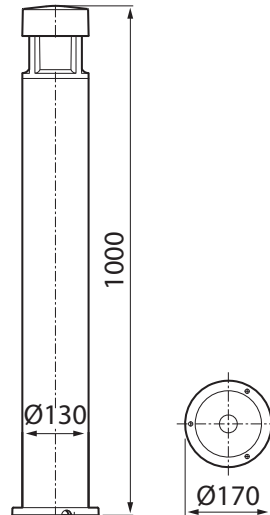
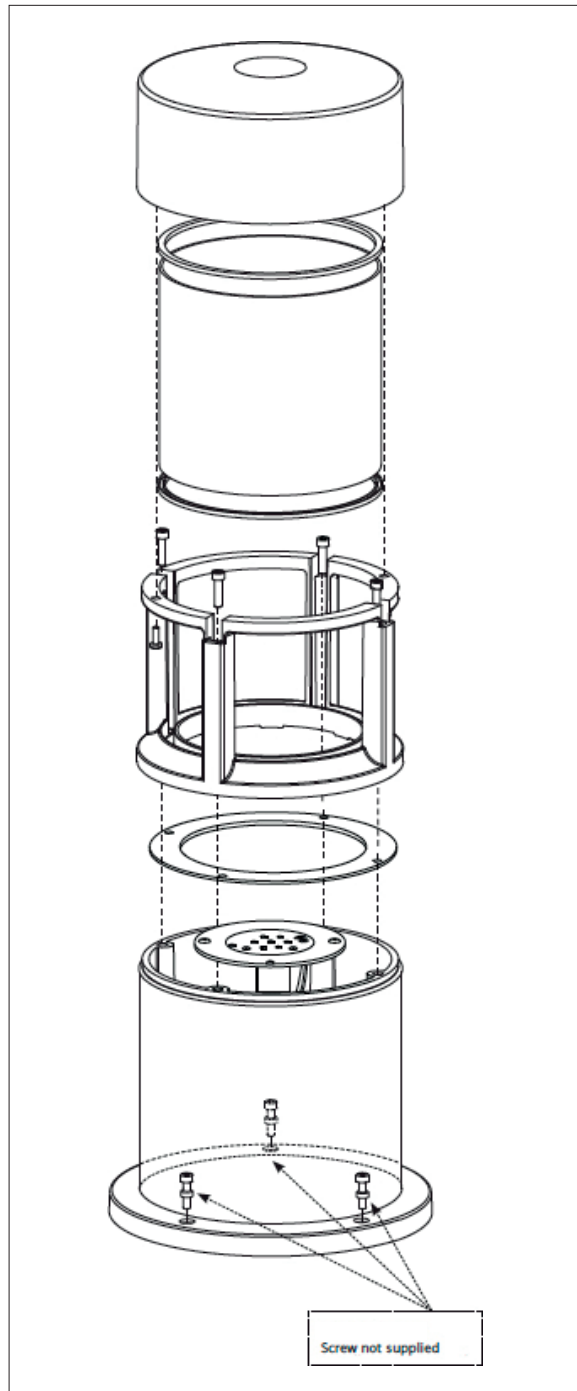

Valaisimen saa asentaa vain sähköalan ammattilainen. Käytä ainoastaan syöttöjännitettä ja taajuutta joka on merkitty valaisimeen/liitäntälaitteeseen. Kytke virta pois päältä ennen asennusta tai huoltoa. Tämä asennusohje on säilytettävä ja sen on oltava käytössä asennuksessa ja huollossa. Tämän valaisimen valonlähde ei ole vaihdettavissa. Kun valonlähde rikkoutuu, koko valaisin on poistettava käytöstä.

Vi rekommenderar att installationen görs av en behörig elektriker. Använd endast driftspänning och frekvens som är märkt på armaturen/förkopplingsdonet. Bryt stömmen före installation eller service. Denna monteringsanvisning bör sparas och finnas tillgänglig vid installation eller framtida service. Ljuskällan till denna armatur kan inte bytas ut. När ljuskällan når sin livslängd ska hela armaturen bytas ut.

Only a professional electrician is allowed to do the installation. Use only rated voltage and frequency as marked in the fixture/driver. Switch off the current before installation or service. This mounting instruction must be kept available during installation and for future maintenance. The light source of this luminaire is not replaceable; when the light source reaches its end of life the whole luminaire shall be replaced.

WARNING: NO REPLACEABLE PARTS INSIDE. The LED source integrated in this luminaire is not expected to be replaced by the user. In case of need ask your dealer.



Floor mounting

CE

CL I

IK 07



IP65 Dust-tight / Jet-proof



Ø cable:  
MIN 5 mm - MAX 10 mm  
H05RN-F



Replace any cracked protective shield with AIRAM original parts

# GRETA MINI

IP65 IK07   -0  
3x2.5  

POLLARI | POLLARE | BOLLARD

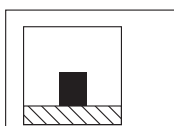
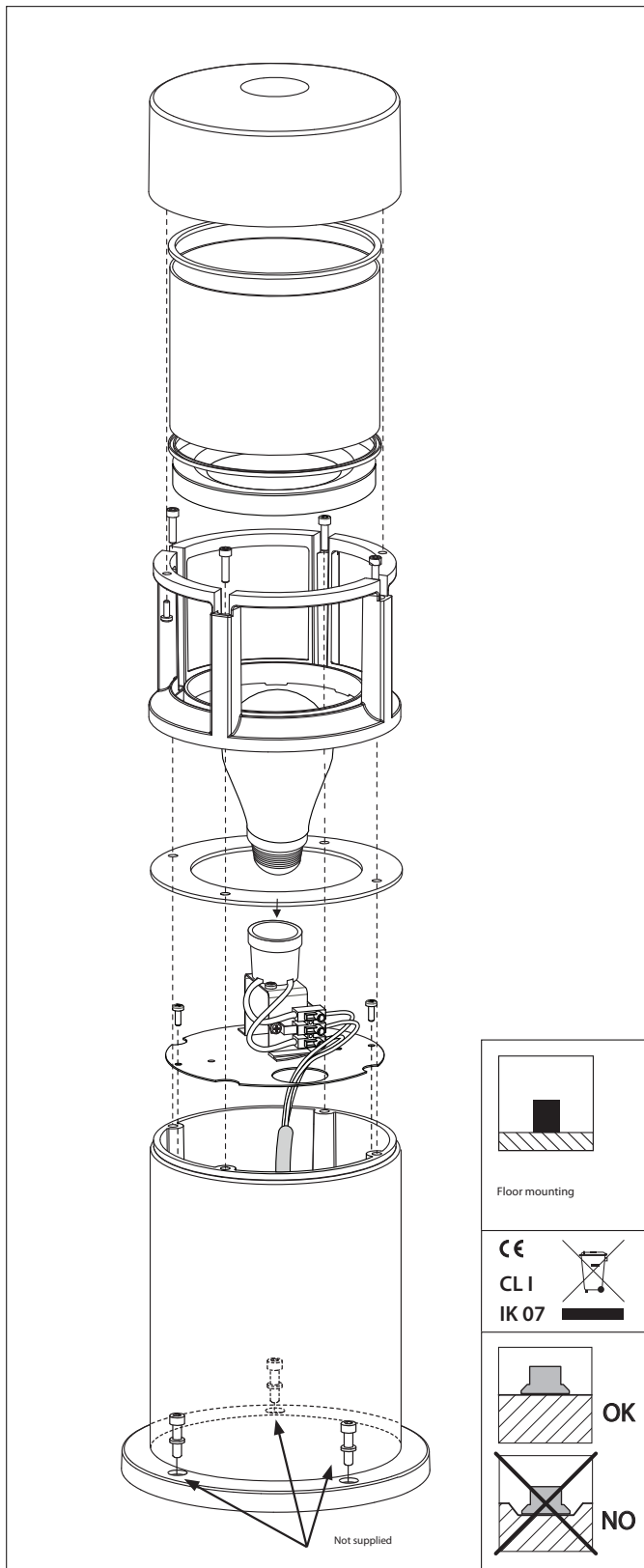

Floor mounting

CE  
CL I   
IK 07 

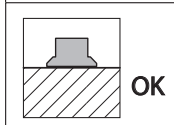

OK



NO

IP65

Dust-tight  
Jet-proof

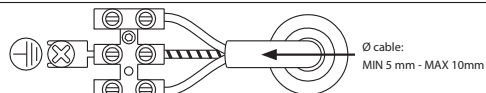

Replace any cracked protective shield  
with AIRAM original parts

## Huolto- ja kierrätysohjeet

## Underhålls- och återvinningsinstruktioner

## Hooldus- ja utiliseerimisjuhend

## Maintenance and recycling instructions

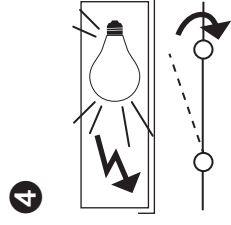
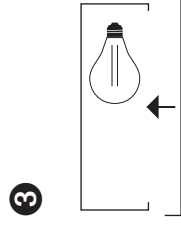
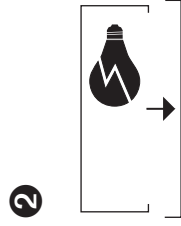
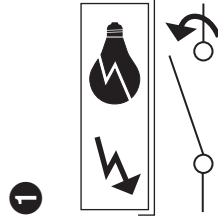
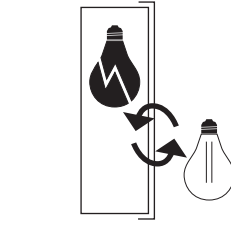
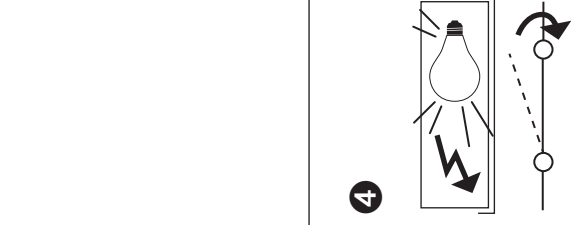
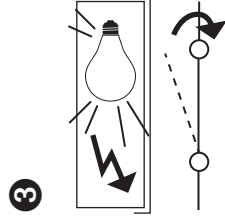
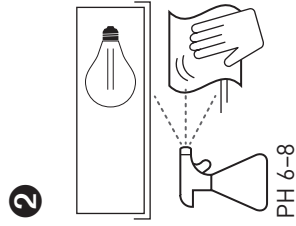
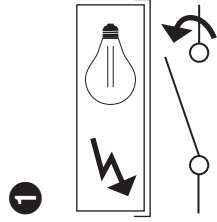
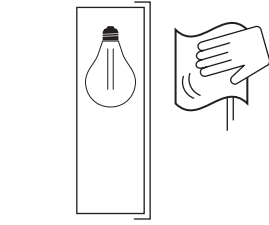
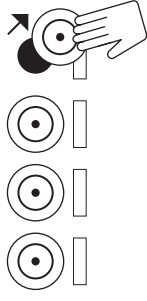
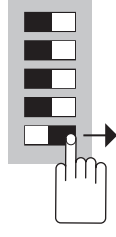
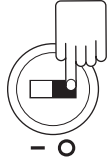
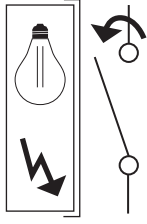

4

Odota, että valaisin on jäähtynyt.  
Väntä tälls lampan har svalnat.  
Oodake, kuni valgusti on jähtunud.  
Wait until the luminaire has cooled down.

